

0 603 365 003

Stand } 02-09  
Issue } 02-11-19

Fig./Abb. 1

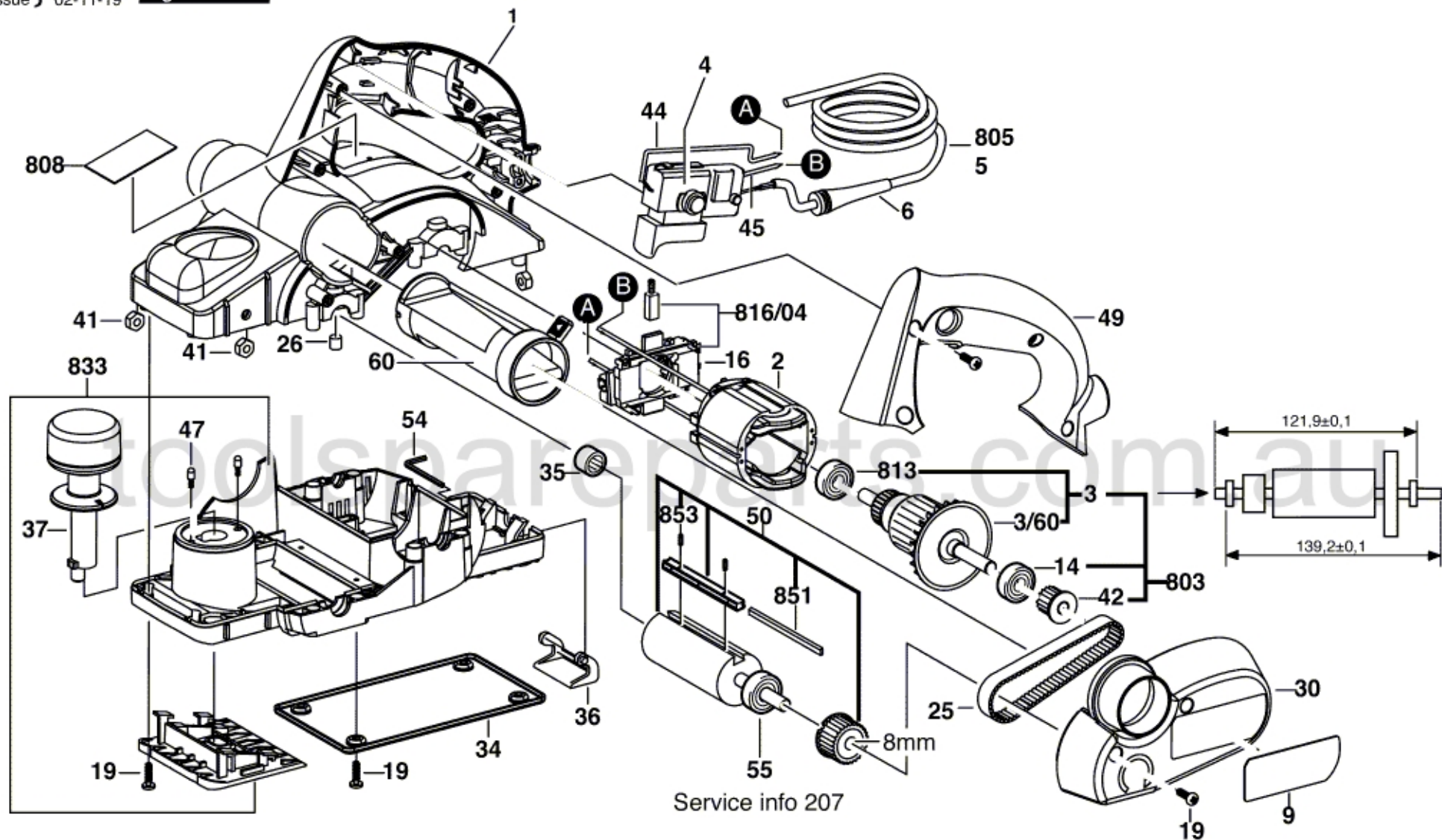

Änderungen vorbehalten  
Modifications reserved  
Modifications reserves  
Salvo modificaciones